

T ECHNICAL INFORMATION



New Tool

Models No. ▶ UH4500

Description ▶ MAKITA 450mm&630mm Hedge Trimmer

CONCEPTION AND MAIN APPLICATIONS

This is a product newly developed on the demands from the European countries, and is to be launched in the gardening tools market. Security and easiness of operation are pursued. It has more power than other manufacturers' products for better effectiveness in work. And two other models of different effective blade length have been developed to meet the demands of the different users.

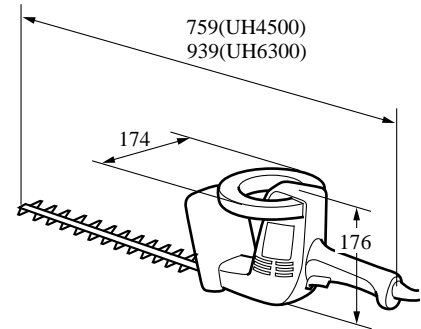

► Specifications

Model	Voltage (V)	Current (A)	Cycle (Hz)	Continuous rating		Max. Output(W)
				Input(W)	Output(W)	
UH4500	100	5.3	50/60	500	250	360
UH6300	100	5.3	50/60	500	250	360

No Load Speed	No. of striking(/min.)	1,700/min.
Effective blade Length (mm)	UH4500	450 mm
	UH6300	630 mm
Net Weight (kg)	UH4500	3.1 kg
	UH6300	3.4 kg
Power supply cord (m)		2.5 m

► Optional accessories

Shear blade assembly

► Repair

Assembly/Disassembly

- 1) Fitting of the gear shaft complete to shear blade assembly
Center the long hole of the shear blades A,B with the round hole of the guide plate. Center the two crank plates with that center as shown in the right sketch. Set ball bearing 6002 and shear blades A,B face to face. After assembling, check if the shear blades A,B move smoothly by turning the gear by hand.

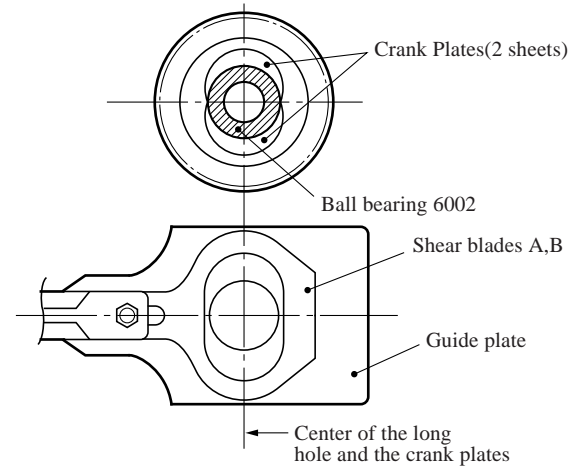

Shear blades

The blade A and the blade B have the same weight so that the vibration of the repeated movement can be offset. Therefore, when there is an inequality of weight due to grinding or breakage of a blade, vibration of the body becomes big in proportion to the imbalance. In such a case the shear blade assembly should be replaced.

Different parts between #UH4500 and # UH 6300(electrical parts excluded)

(1) Main Body

Substitute parts

Shear blade assembly — 1 piece
identification plate — 1 piece

Additional parts

none

Excluded parts

none

(2) Normal Accessories

Substitute piece

Card board case — 1

Additional piece

none

Excluded piece

none

Operation Mode

(1) Switch operation

Two different switches should be activated to start operation because this tool has adopted double hand switch mechanism. For activation, the main switch on the grip should be pulled by one hand and the loop-shaped sub switch on the handle held by the other. If either of the two switches is released, the machine will stop.

