

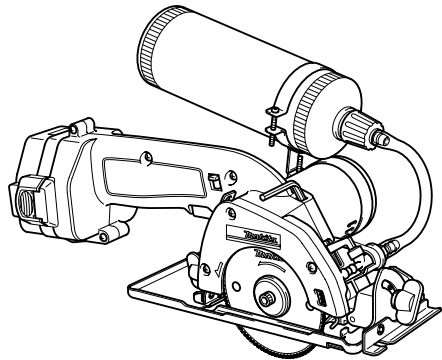

Cordless Cutter

85 mm (3-3/8")
MODEL 4191D



003506

I N S T R U C T I O N M A N U A L

⚠ WARNING:

For your personal safety, READ and UNDERSTAND before using.
SAVE THESE INSTRUCTIONS FOR FUTURE REFERENCE.

SPECIFICATIONS

Model		4191D
Blade diameter		85 mm (3-3/8")
Cutting depth	90°	0 - 24 mm (0 - 15/16")
	45°	0 - 18 mm (0 - 11/16")
No load speed (RPM)		1,000/min.
Overall length		316 mm (12-1/2")
Net weight		2.1 kg (4.6 lbs)
Rated voltage		D.C. 12V
Standard battery cartridges		1222, 1233, 1234, 1235

- Manufacturer reserves the right to change specifications without notice.
- Specifications may differ from country to country.

GENERAL SAFETY RULES

USA003-1

(FOR ALL BATTERY OPERATED TOOLS)

WARNING:

Read and understand all instructions. Failure to follow all instructions listed below, may result in electric shock, fire and/or serious personal injury.

SAVE THESE INSTRUCTIONS

Work Area

1. **Keep your work area clean and well lit.** Cluttered benches and dark areas invite accidents.
2. **Do not operate power tools in explosive atmospheres, such as in the presence of flammable liquids, gases, or dust.** Power tools create sparks which may ignite the dust or fumes.

3. **Keep bystanders, children, and visitors away while operating a power tool.** Distractions can cause you to lose control.

Electrical Safety

4. **A battery operated tool with integral batteries or a separate battery pack must be recharged only with the specified charger for the battery.** A charger that may be suit-

able for one type of battery may create a risk of fire when used with another battery.

5. **Use battery operated tool only with specifically designated battery pack.** Use of any other batteries may create a risk of fire.

Personal Safety

6. **Stay alert, watch what you are doing, and use common sense when operating a power tool. Do not use tool while tired or under the influence of drugs, alcohol, or medication.** A moment of inattention while operating power tools may result in serious personal injury.
7. **Dress properly. Do not wear loose clothing or jewelry. Contain long hair. Keep your hair, clothing, and gloves away from moving parts.** Loose clothes, jewelry, or long hair can be caught in moving parts.
8. **Avoid accidental starting. Be sure switch is in the locked or off position before inserting battery pack.** Carrying tools with your finger on the switch or inserting the battery pack into a tool with the switch on invites accidents.
9. **Remove adjusting keys or wrenches before turning the tool on.** A wrench or a key that is left attached to a rotating part of the tool may result in personal injury.
10. **Do not overreach. Keep proper footing and balance at all times.** Proper footing and balance enable better control of the tool in unexpected situations.
11. **Use safety equipment. Always wear eye protection.** Dust mask, non-skid safety shoes, hard hat, or hearing protection must be used for appropriate conditions.

Tool Use and Care

12. **Use clamps or other practical way to secure and support the workpiece to a stable platform.** Holding the work by hand or against your body is unstable and may lead to loss of control.

13. **Do not force tool. Use the correct tool for your application.** The correct tool will do the job better and safer at the rate for which it is designed.

14. **Do not use tool if switch does not turn it on or off.** A tool that cannot be controlled with the switch is dangerous and must be repaired.

15. **Disconnect battery pack from tool or place the switch in the locked or off position before making any adjustments, changing accessories, or storing the tool.** Such preventive safety measures reduce the risk of starting the tool accidentally.

16. **Store idle tools out of reach of children and other untrained persons.** Tools are dangerous in the hands of untrained users.

17. **When battery pack is not in use, keep it away from other metal objects like: paper clips, coins, keys, nails, screws, or other small metal objects that can make a connection from one terminal to another.** Shorting the battery terminals together may cause sparks, burns, or a fire.

18. **Maintain tools with care. Keep cutting tools sharp and clean.** Properly maintained tools with sharp cutting edge are less likely to bind and are easier to control.

19. **Check for misalignment or binding of moving parts, breakage of parts, and any other condition that may affect the tool's operation. If damaged, have the tool serviced before using.** Many accidents are caused by poorly maintained tools.

20. **Use only accessories that are recommended by the manufacturer for your model.** Accessories that may be suitable for one tool may create a risk of injury when used on another tool.

SERVICE

21. **Tool service must be performed only by qualified repair personnel.** Service or maintenance performed by unqualified personnel may result in a risk of injury.

22. When servicing a tool, use only identical replacement parts. Follow instructions in the Maintenance section of this manual.

Use of unauthorized parts or failure to follow Maintenance instructions may create a risk of shock or injury.

SPECIFIC SAFETY RULES

USB070-1

DO NOT let comfort or familiarity with product (gained from repeated use) replace strict adherence to cordless cutter safety rules. If you use this tool unsafely or incorrectly, you can suffer serious personal injury.

- 1. DANGER! Keep hands away from cutting area and wheel. Keep your second hand on auxiliary handle or motor housing.** If both hands are holding the tool, they cannot be cut by the wheel.
- 2. Keep your body positioned to either side of the wheel, but not in line with the wheel.** KICKBACK could cause the tool to jump backwards. (See "Causes and Operator Prevention of Kickback")
- 3. Do not reach underneath the work.**
- 4. Always observe that the wheel has stopped spinning before placing tool down on bench or floor.** A coasting wheel will cause the tool to walk backwards, cutting whatever is in its path. Be aware of the time it takes for the wheel to stop after switch is released.
- 5. NEVER hold piece being cut in your hands or across your leg.** It is important to support the work properly to minimize body exposure, wheel binding, or loss of control.
- 6. Hold tool by insulated gripping surfaces when performing an operation where the cutting tool may contact hidden wiring.** Contact with a "live" wire will also make exposed metal parts of the tool "live" and shock the operator.
- 7. When ripping always use a rip fence or straight edge guide.** This improves the accuracy of cut and reduces the chance for wheel binding.
- 8. Always use wheels with correct size and shape (diamond vs. round) arbor holes.** Wheels that do not match the mounting hardware of the tool will run eccentrically, causing loss of control.
- 9. Never use damaged or incorrect wheel washers or bolts.** The wheel washers and bolt were specially designed for your tool, for optimum performance and safety of operation.
- 10. Causes and Operator Prevention of Kickback:**

Kickback is a sudden reaction to a pinched, bound, or misaligned wheel, causing an uncontrolled tool to lift up and out of the work-piece toward the operator.

When the wheel is pinched or bound tightly by the kerf closing down, the wheel stalls and the motor reaction drives the unit rapidly back toward the operator.

If the wheel becomes twisted or misaligned in the cut, the teeth at the back edge of the wheel can dig into the top surface of the wood causing the wheel to climb out of the kerf and jump back toward the operator.

Kickback is the result of tool misuse and/or incorrect operating procedures or conditions and can be avoided by taking proper precautions as given below:

Maintain a firm grip on the tool and posi-

tion your body and arm in a way that allows you to resist KICKBACK forces. KICKBACK forces can be controlled by the operator, if proper precautions are taken.

When wheel is binding, or when interrupting a cut for any reason, release the trigger and hold the tool motionless in the material until the wheel comes to a complete stop. Never attempt to remove the tool from the work or pull the tool backward while the wheel is in motion or KICKBACK may occur. Investigate and take corrective actions to eliminate the cause of wheel binding.

When restarting a tool in the workpiece, center the wheel in the kerf and check that teeth are not engaged into the material. If wheel is binding, it may walk up or KICKBACK from the workpiece as the tool is restarted.

Support large panels to minimize the risk of wheel pinching and KICKBACK. Large panels tend to sag under their own weight. Supports must be placed under the panel on both sides, near the line of cut and near the edge of the panel.

To minimize the risk of wheel pinching and kickback. When cutting operation requires the resting of the tool on the workpiece, the tool shall be rested on the larger portion and the smaller piece cut off.

Do not use dull or damaged wheel. Unsharpened or improperly set wheels produce narrow kerf causing excessive friction, wheel binding and KICKBACK.

Wheel depth and bevel adjusting locking levers must be tight and secure before making cut. If wheel adjustment shifts while cutting, it will cause binding and KICKBACK.

Use extra caution when making a “Pocket Cut” into existing walls or other blind areas. The protruding wheel may cut objects that can cause KICKBACK.

11. **Use only diamond wheels. NEVER use tool with wood cutting blades or other sawblades. Such blades when used on**

this tool frequently kick and cause loss of control leading to personal injury.

12. **Check the wheel carefully for cracks or damage before operation. Replace cracked or damaged wheel immediately.**
13. **Use only flanges specified for this tool.**
14. **Be careful not to damage the spindle, flanges (especially the installing surface) or bolt. Damage to these parts could result in wheel breakage.**
15. **Hold the tool firmly.**
16. **Make sure the wheel is not contacting the workpiece before the switch is turned on.**
17. **Wait until the wheel attains full speed before cutting.**
18. **Stop operation immediately if you notice anything abnormal.**
19. **Never attempt to cut with the tool held upside down in a vise. This can lead to serious accidents, because it is extremely dangerous.**
20. **Do not stop the wheel by lateral pressure on the disc.**
21. **Some material contains chemicals which may be toxic. Take caution to prevent dust inhalation and skin contact. Follow material supplier safety data.**

SAVE THESE INSTRUCTIONS

⚠ WARNING:
MISUSE or failure to follow the safety rules stated in this instruction manual may cause serious personal injury.

SYMBOLS

USD301-1

The followings show the symbols used for tool.

V volts

n_0 no load speed

$\overleftarrow{\text{---}}$ direct current

.../min.....revolutions or reciprocation per minute

IMPORTANT SAFETY INSTRUCTIONS FOR BATTERY CARTRIDGE

ENC004-1

1. Before using battery cartridge, read all instructions and cautionary markings on (1) battery charger, (2) battery, and (3) product using battery.
2. Do not disassemble battery cartridge.
3. If operating time has become excessively shorter, stop operating immediately. It may result in a risk of overheating, possible burns and even an explosion.
4. If electrolyte gets into your eyes, rinse them out with clear water and seek medical attention right away. It may result in loss of your eyesight.
5. Always cover the battery terminals with the battery cover when the battery cartridge is not used.
6. Do not short the battery cartridge:
 - (1) Do not touch the terminals with any conductive material.
 - (2) Avoid storing battery cartridge in a container with other metal objects such as nails, coins, etc.
 - (3) Do not expose battery cartridge to water or rain.

A battery short can cause a large current flow, overheating, possible burns and even a breakdown.
7. Do not store the tool and battery cartridge in locations where the temperature may reach or exceed 50°C (122°F).

8. Do not incinerate the battery cartridge even if it is severely damaged or is com-

pletely worn out. The battery cartridge can explode in a fire.

9. Be careful not to drop or strike battery.

SAVE THESE INSTRUCTIONS

Tips for maintaining maximum battery life

1. Charge the battery cartridge before completely discharged.

Always stop tool operation and charge the battery cartridge when you notice less tool power.

2. Never recharge a fully charged battery cartridge.

Overcharging shortens the battery service life.

3. Charge the battery cartridge with room temperature at 10°C - 40°C (50°F - 104°F). Let a hot battery cartridge cool down before charging it.

4. Charge the Nickel Metal Hydride battery cartridge when you do not use it for more than six months.

FUNCTIONAL DESCRIPTION

⚠ CAUTION:

- Always be sure that the tool is switched off and the battery cartridge is removed before adjusting or checking function on the tool.

001327

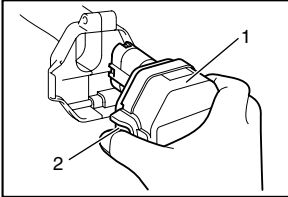

1. Battery cartridge
2. Button

Installing or removing battery cartridge

- Always switch off the tool before insertion or removal of the battery cartridge.
- To remove the battery cartridge, withdraw it from the tool while pressing the buttons on both sides of the cartridge.
- To insert the battery cartridge, align the tongue on the battery cartridge with the groove in the housing and slip it into place. Always insert it all the way until it locks in place with a little click. If not, it may accidentally fall out of the tool, causing injury to you or someone around you.
- Do not use force when inserting the battery cartridge. If the cartridge does not slide in easily, it is not being inserted correctly.

003512

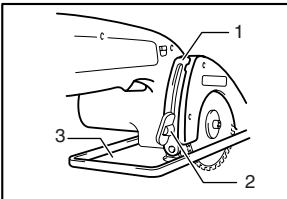

1. Depth guide
2. Clamping screw
3. Base

Adjusting the depth of cut

Loosen the clamping screw on the depth guide and move the base up or down.

003513

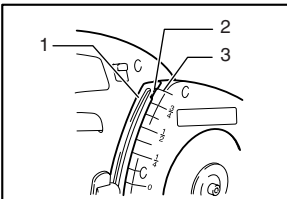

1. Depth guide
2. Top of notch
3. Graduation

You can read the depth of cut by aligning the top of the notch in the depth guide with the graduations on its right side. (Note: This can be done for 0° bevel cutting only.)

At the desired depth of cut, secure the base by tightening the clamping screw.

⚠ CAUTION:

- Use a shallow depth of cut when cutting thin workpiece for cleaner, safer cuts.
- After adjusting the depth of cut, always tighten the clamping screw securely.

003517

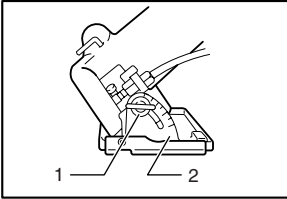

1. Clamping screw
2. Bevel scale plate

Bevel cutting

Loosen the clamping screw on the bevel scale plate on the front of the base. Set for the desired angle (0° - 45°) by tilting accordingly, then tighten the clamping screw securely.

003521

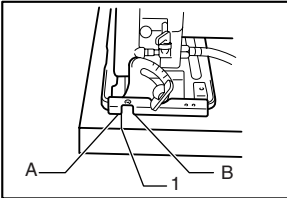

1. Cutting line

Sighting

For straight cuts, align the A position on the front of the base with your cutting line. For 45° bevel cuts, align the B position with it.

003525

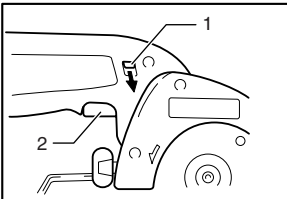

1. Lock-off lever
2. Switch trigger

Switch action

⚠ CAUTION:

- Before inserting the battery cartridge into the tool, always check to see that the switch trigger actuates properly and returns to the “OFF” position when released.

To prevent the switch trigger from being accidentally pulled, a lock-off lever is provided.

To start the tool, slide the lock-off lever in the direction of the arrow and pull the switch trigger. Release the switch trigger to stop.

ASSEMBLY

⚠ CAUTION:

- Always be sure that the tool is switched off and the battery cartridge is removed before carrying out any work on the tool.

003531

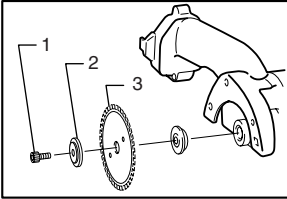

1. Bolt
2. Flange
3. Diamond wheel

Installing or removing diamond wheel

To install the wheel, first loosen the bolt with the hex wrench and remove the bolt and the flange. Then mount the wheel, the flange and the bolt. The wheel should be mounted with the Makita name on the flange side.

003532

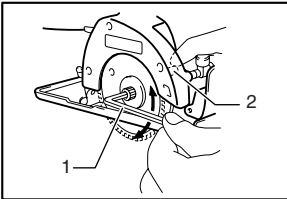

1. Hex wrench
2. Shaft lock

Press the shaft lock so that the wheel cannot revolve. Use the hex wrench to tighten the bolt securely.

To remove the wheel, follow the installation procedure in reverse.

⚠ CAUTION:

- When installing the wheel, be sure to tighten the bolt securely.
- Use only the Makita wrench to install or remove the wheel.

001452

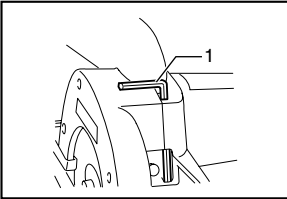

1. Hex wrench

Hex wrench storage

When not in use, store the hex wrench as shown in the figure to keep it from being lost.

003538

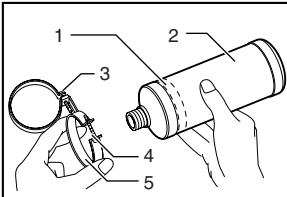

1. Tank holder installing portion
2. Tank
3. Screw (B)
4. Screw (A)
5. Tank holder

Installing water supply

Attach the tank holder on the tank. The tank holder should be attached around the portion shown with the dotted line. Tighten the screw (A) to the extent that the tank can still turn within the tank holder.

003539

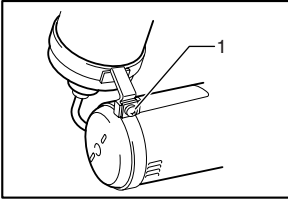

1. Screw (B)

Attach the tank holder onto the motor housing. Tighten the screw (B) securely.

003540

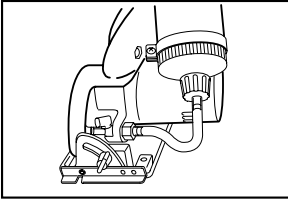

Connect the cap on the end of the polyvinyl tube to the mouth of the tank. Turn the tank clockwise when making the connection. Then tighten the screw (A) securely to secure the tank.

⚠ CAUTION:

- If you find the polyvinyl tube is bent like a “V” or has been strained excessively after installing the water supply, loosen the screw (B) and adjust the position of the tank to alleviate the bent, pinched or strained condition.

003542

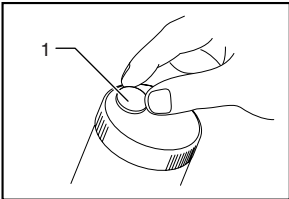

1. Cap

Water supply

Remove the cap on the tank and fill through the hole. Recap the tank. Be sure that the water cock is turned off when filling the tank with water.

⚠ CAUTION:

- When filling the tank with water, be careful not to let the tool get wet.

OPERATION

003547

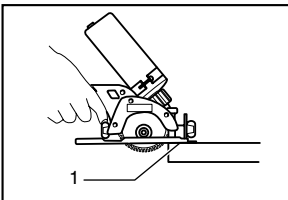

1. Base

Hold the tool firmly. Set the base plate on the workpiece to be cut without the wheel making any contact. Then turn the tool on and wait until the wheel attains full speed. Feed water to the wheel by adjusting the water cock to obtain a gentle flow of water. Move the tool forward over the workpiece surface, keeping it flat and advancing smoothly until the cutting is completed. Keep your cutting line straight and your speed of advance uniform.

For fine, clean cuts, cut slowly. (When cutting glass plate 5 mm (3/16”) thick, cut at about 250 mm/min (9-7/8”/min). When cutting tile 10 mm (3/8”) thick, cut at about 300 mm/

min (11-13/16"/min.) Also slow down as you complete a cut to avoid breaking or cracking the workpiece being cut.

⚠ CAUTION:

- Be sure to hold the workpiece firmly down on a stable bench or table during operation.
- Do not twist or force the tool in the cut, or the motor may be overloaded or the workpiece may break.
- Do not use the tool with the wheel in an upward or sideways position.
- When cutting glass plate, it is recommended to attach a rubber plate (optional accessory) on the base of the tool to prevent the workpiece surface from being scratched.
- The wheel for this tool is a wet-type wheel for glass and tile applications. Be sure to feed water to the wheel during operation.
- If the cutting action of the wheel begins to diminish, dress the cutting edge of the wheel using an old discarded coarse grit bench grinder wheel or concrete block. Dress by pressing lightly on the outer edge of the wheel.

NOTE:

- If the tool is operated continuously until the battery cartridge has discharged, allow the tool to rest for 15 minutes before proceeding with a fresh battery.

MAINTENANCE

⚠ CAUTION:

- Always be sure that the tool is switched off and the battery cartridge is removed before attempting to perform inspection or maintenance.

After use

Brush off accumulation of dust on the base.

To maintain product SAFETY and RELIABILITY, repairs, any other maintenance or adjustment should be performed by Makita Authorized or Factory Service Centers, always using Makita replacement parts.

EN0001-1

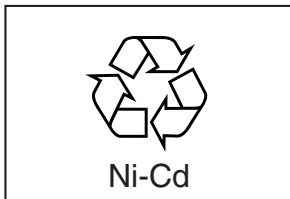

Recycling the Battery

The only way to dispose of a Makita battery is to recycle it. The law prohibits any other method of disposal.

To recycle the battery:

1. Remove the battery from the tool.
2. a) Take the battery to your nearest Makita Factory Service Center
or
b) Take the battery to your nearest Makita Authorized Service Center or Distributor that has been designated as a Makita battery recycling location.

Call your nearest Makita Service Center or Distributor to determine the location that provides Makita battery recycling. See your local Yellow Pages under "Tools-Electric".

ACCESSORIES

⚠ CAUTION:

- These accessories or attachments are recommended for use with your Makita tool specified in this manual. The use of any other accessories or attachments might present a risk of injury to persons. Only use accessory or attachment for its stated purpose.

If you need any assistance for more details regarding these accessories, ask your local Makita service center.

- Diamond wheels
- Hex wrench 4
- Various type of Makita genuine batteries and chargers

Cut



**Makita Canada Inc.
1950 Forbes Street,
Whitby, Ontario
L1N 7B7**

Stamp
Timbre

Fold

Your answers to the following questions are appreciated.

1. This product was purchased from?

- Hardware/lumber Store Industrial Supply
 Tool Distributor Other ()

3. How did you first learn of Makita Power Tools?

- Magazine/Newspaper Catalog
 From dealer Other ()
 Store display

2. Use of the product is intended for?

- Construction trade Home maintenance
 Industrial maintenance Other ()

4. Most favored points are?

- Design Makita Brand
 Features Power
 Size Other ()
 Price

5. Any comments?

Certificate of Warranty Mail to Makita

Date Purchased Month: <input style="width: 30px; height: 20px;" type="text"/> <input style="width: 30px; height: 20px;" type="text"/> Day: <input style="width: 30px; height: 20px;" type="text"/> <input style="width: 30px; height: 20px;" type="text"/> Year 20: <input style="width: 30px; height: 20px;" type="text"/> <input style="width: 30px; height: 20px;" type="text"/>	Model No. <input style="width: 100%; height: 20px;" type="text"/> <hr/> Serial No. <input style="width: 100%; height: 20px;" type="text"/>
Initial Last Name: <input style="width: 100%; height: 20px;" type="text"/>	
Male <input type="checkbox"/> Female <input type="checkbox"/> Single <input type="checkbox"/> Married <input type="checkbox"/>	
Street Address: <input style="width: 100%; height: 20px;" type="text"/>	
City: <input style="width: 90%; height: 20px;" type="text"/>	Province: <input style="width: 90%; height: 20px;" type="text"/>
Postal Code: <input style="width: 100%; height: 20px;" type="text"/>	
AGE: <input type="checkbox"/> Under 19 <input type="checkbox"/> 20-29 <input type="checkbox"/> 30-39 <input type="checkbox"/> 40-49 <input type="checkbox"/> Over 50	

Occupation:

Dealer's Name & Address:

Factory Service Centres

Head Office:	1950 Forbes St., Whitby, Ontario, L1N 7B7 (905) 571 - 2200	1-800-263-3734
Regional Office:	11771 Hammersmith Way, Richmond B.C. V7A 5H6 (604) 272 - 3104	1-800-663-0909
Regional Office: (Montreal)	6389 boul. Couture, St. Leonard, Quebec H1P 3J5 (514) 323 - 1223	1-800-361-7049
Dartmouth:	202 Brownlow Avenue Dartmouth, N.S., B3B 1T5 (902) 468 - 7064	1-888-625-4821
Ville St. Laurent: (Montreal)	1140 Rue Bégin, Ville St. Laurent, Quebec H4R 1X1 (514) 745 - 5025	1-888-745-5025
Les Saules: (Quebec)	1200 St. Jean Baptiste, Unit 106, Les Saules, Quebec, G2E 5E8 (418) 871 - 5720	1-800-663-5757
Nepean: (Ottawa)	210 Colonnade Road, Unit 11, Nepean, Ontario, K2E 7M1 (613) 224 - 5022	1-888-560-2214
Whitby:	1950 Forbes St., Whitby, Ontario, L1N 7B7 (905) 571 - 2200	1-800-263-3734
London:	317 Adelaide St. S., Unit 117, London, Ontario, N5Z 3L3 (519) 686 - 3115	1-800-571-0899
Mississauga:	6350 Tomken Rd., Unit 8, Mississauga, Ontario, L5T 1Y3 (905) 670 - 7255	1-888-221-9811
Calgary:	#8-6115 Fourth St. S.E., Calgary Alberta, T2H 2H9 (403) 243 - 3995	1-800-267-0445
Edmonton:	11614-149 Street, Edmonton, Alberta, T5M 3R3 (780) 455 - 6644	1-888-455-6644
Richmond:	11771 Hammersmith Way, Richmond, B.C., V7A 5H6 (604) 272 - 3104	1-800-663-0909
Winnipeg:	1670 St. James Street, Winnipeg, Manitoba, R3H 0L3 (204) 694 - 0402	1-800-550-5073
Saskatoon:	206A-2750 Faithful Avenue Saskatoon, Saskatchewan, S7K 6M6 (306) 931 - 0111	1-888-931-0111

For the authorized service centre nearest you please refer to the local yellow pages directory under "tools" or contact our customer service department (Tel) 1-800-263-3734

When you need service...

- Explain the problem in a letter
- Enclose the letter with the tool
- Package carefully and send prepaid to the nearest Makita factory or authorized service centre

CUSTOMER RECORD

DATE
PURCHASED: _____

DEALER'S NAME
& ADDRESS: _____

MODEL NO.: _____

SERIAL NO.: _____

MAKITA LIMITED ONE YEAR WARRANTY

Warranty Policy

Every Makita tool is thoroughly inspected and tested before leaving the factory. It is warranted to be free of defects from workmanship and materials for the period of ONE YEAR from the date of original purchase. Should any trouble develop during this one year period, return the COMPLETE tool, freight prepaid, to one of Makita's Factory or Authorized Service Centres. If inspection shows the trouble is caused by defective workmanship or material, Makita will repair (or at our option, replace) without charge.

This Warranty does not apply:

- where normal maintenance is required,
- repairs have been made or attempted by others,
- the tool has been abused, misused or improperly maintained,
- alterations have been made to the tool.

IN NO EVENT SHALL MAKITA BE LIABLE FOR ANY INDIRECT, INCIDENTAL OR CONSEQUENTIAL DAMAGES FROM THE SALE OR USE OF THE PRODUCT. THIS DISCLAIMER APPLIES BOTH DURING AND AFTER THE TERM OF THIS WARRANTY.

"The Makita Warranty is the only and the entire written warranty given by Makita for the Makita tools. No dealer or his agent or employee is authorized to extend or enlarge upon this warranty by any verbal or written statement or advertisement."

MAKITA DISCLAIMS LIABILITY FOR ANY IMPLIED WARRANTIES INCLUDING IMPLIED WARRANTIES OF "MERCHANTABILITY" AND FITNESS FOR A SPECIFIC PURPOSE," AFTER THE ONE YEAR TERM OF THIS WARRANTY.

"This Warranty gives you specific rights. The provisions contained in this warranty are not intended to limit, modify, take away from, disclaim or exclude any warranties set forth in any provincial legislation. To the extent required by law, the provisions in any provincial or federal legislation with respect to warranties take precedence over the provisions in this warranty."

Makita Corporation of America

2650 Buford Hwy., Buford, GA 30518